

INSTALLATION GUIDE | VERLEGEANLEITUNG

SWISSCLIC PANEL-A+ WITH RAILS SYSTEM

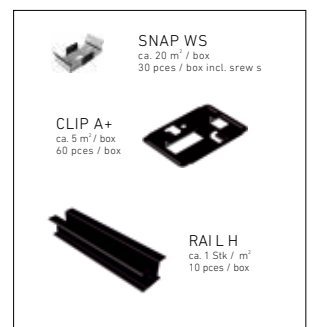

START

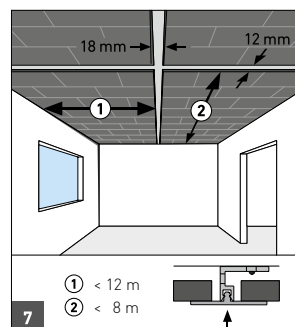
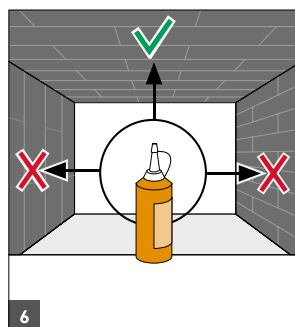
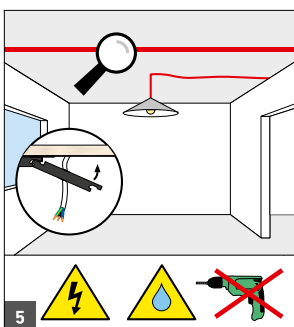
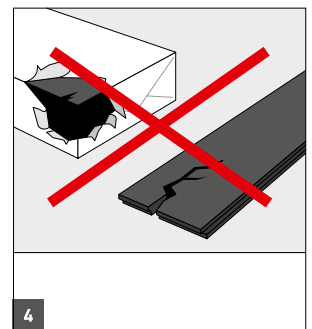
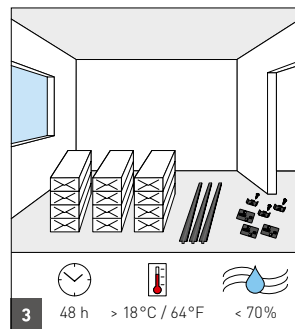
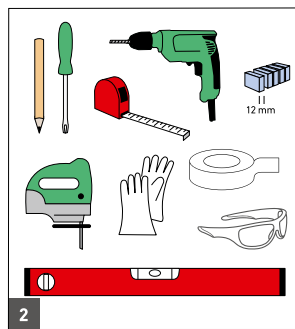
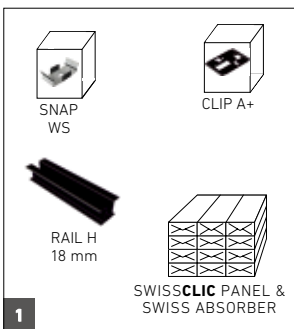
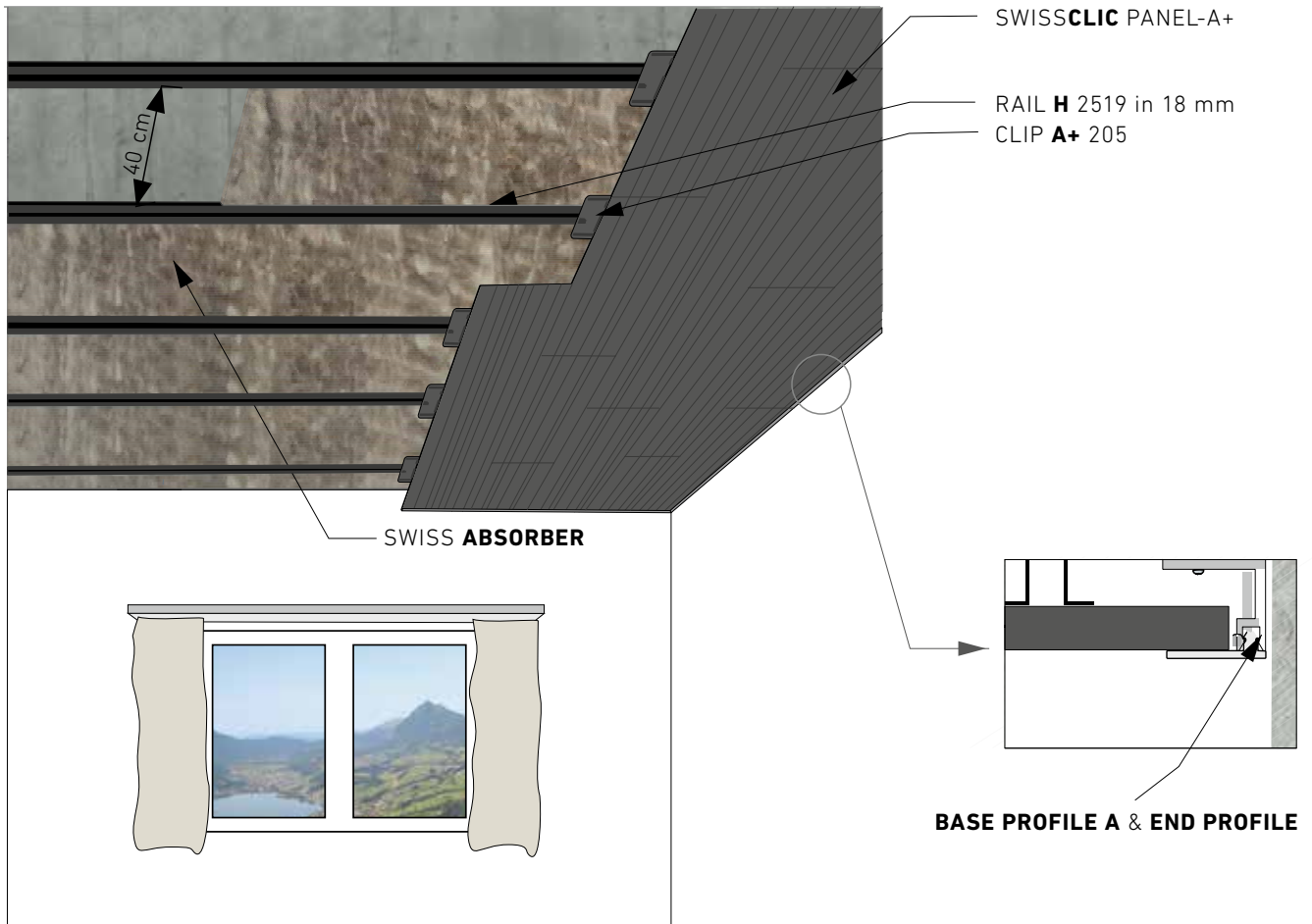
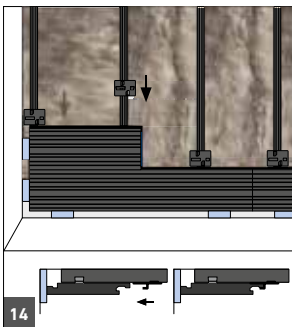
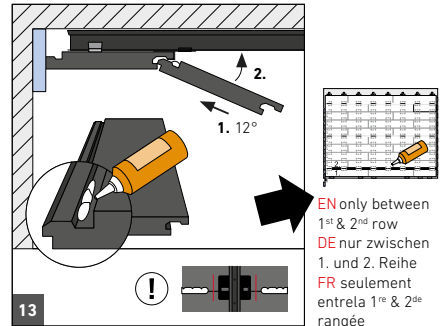
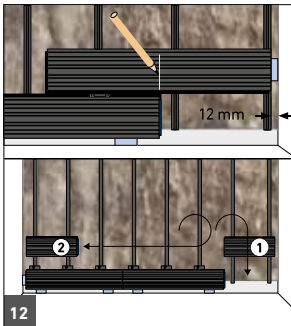
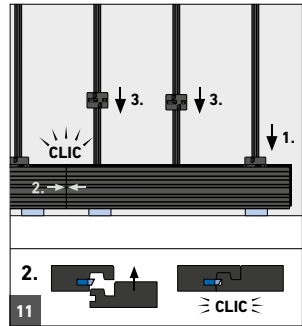
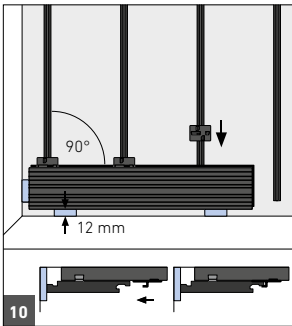
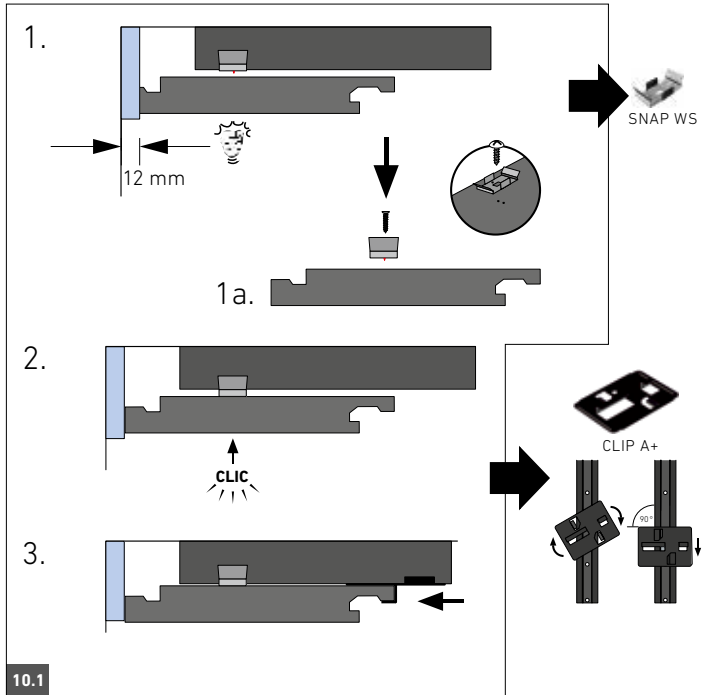
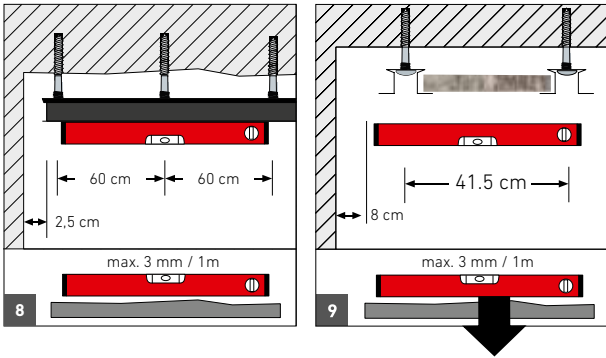

FOR INSTALLATION WITHOUT BASE & END PROFIL

SIDE CUT

TOP VIEW

> 5 cm

EN
If the distance is > 5 cm = put **elastic silicon glue** between SWISSCLIC PANEL and the RAIL subconstruction to hold the small lamellas.

DE
Bei > 5 cm Distanz zum Steg = Setze **elastischen Silikonkleber** zwischen das SWISSCLIC PANEL und die RAIL Unterkonstruktion um die schmalen Lamellen zu halten.

FR
Pour une distance de > 5 cm jusqu'à la traverse = Mettez une **colle elastique silicone** entre le SWISSCLIC PANEL et le RAIL de sous-construction pour fixer les minces lamelles.

END

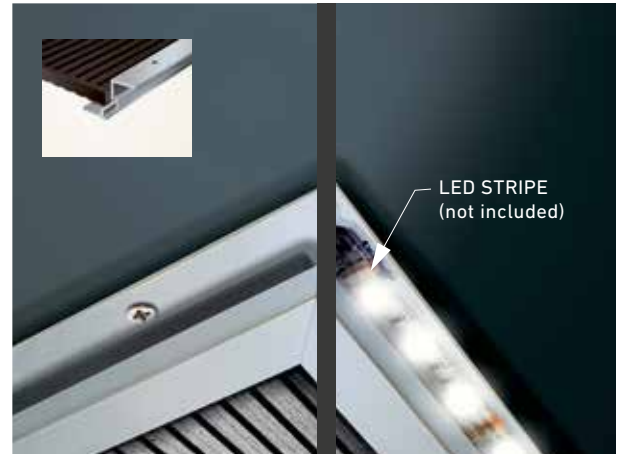
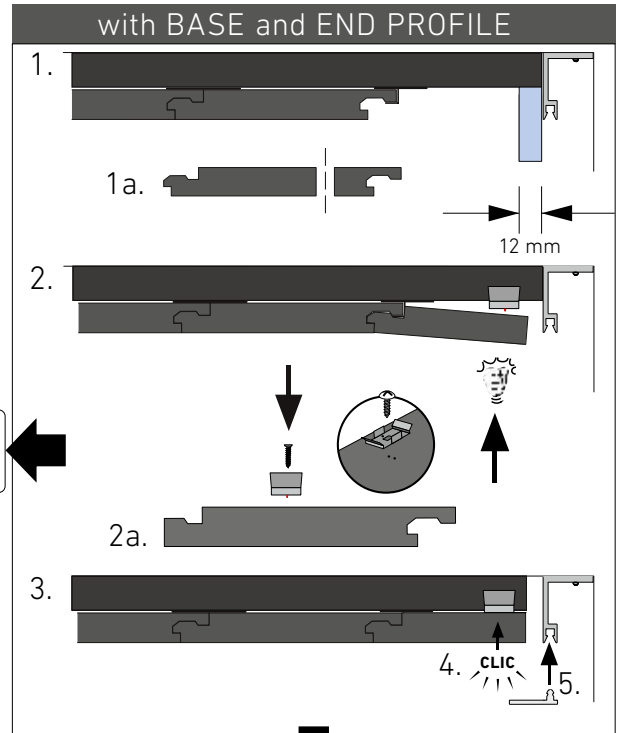
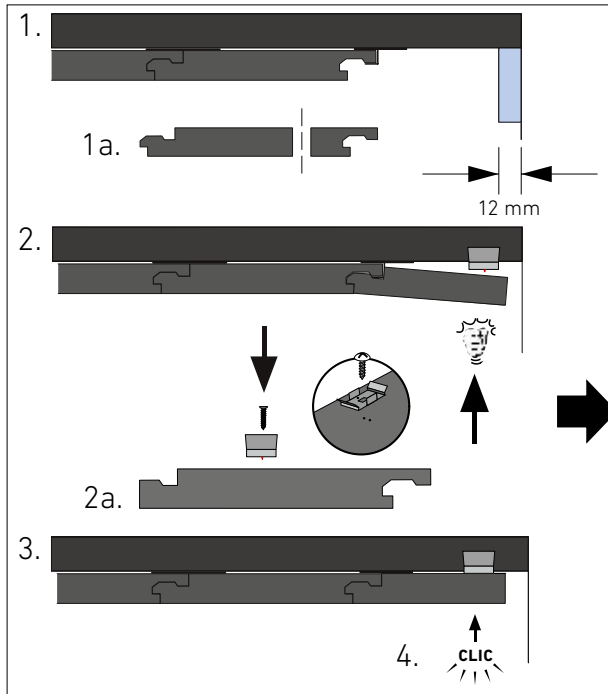

INSTALLATION GUIDE | VERLEGEANLEITUNG

SWISSCLIC PANEL-A+ ON WOOD

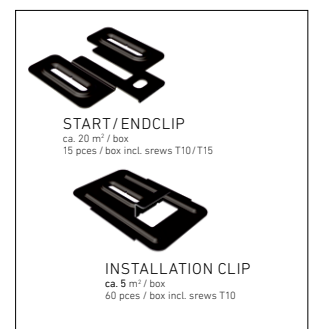
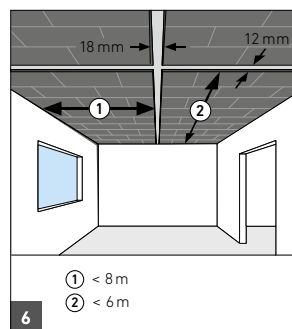
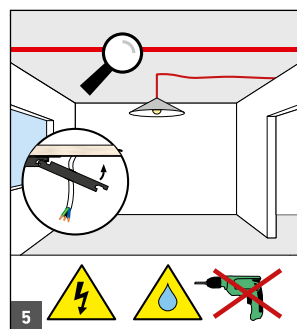
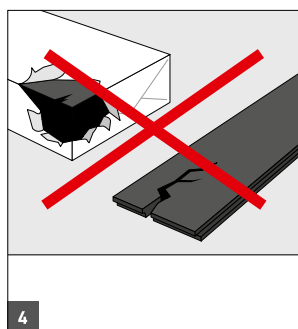
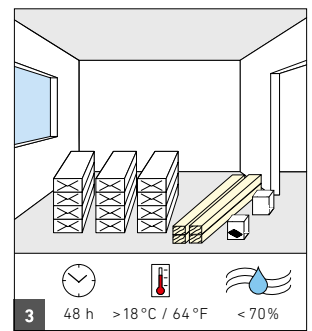
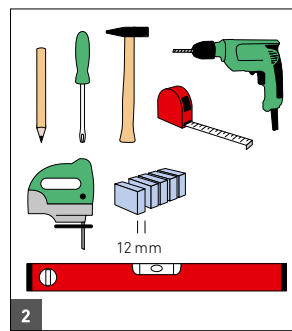
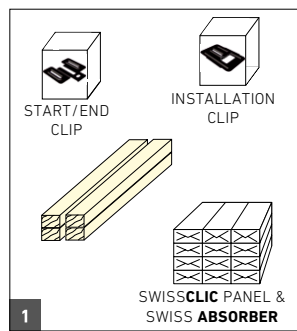
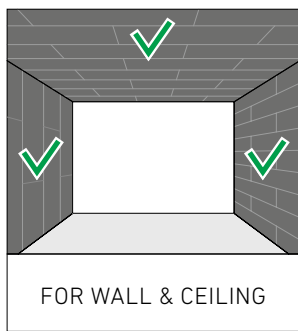
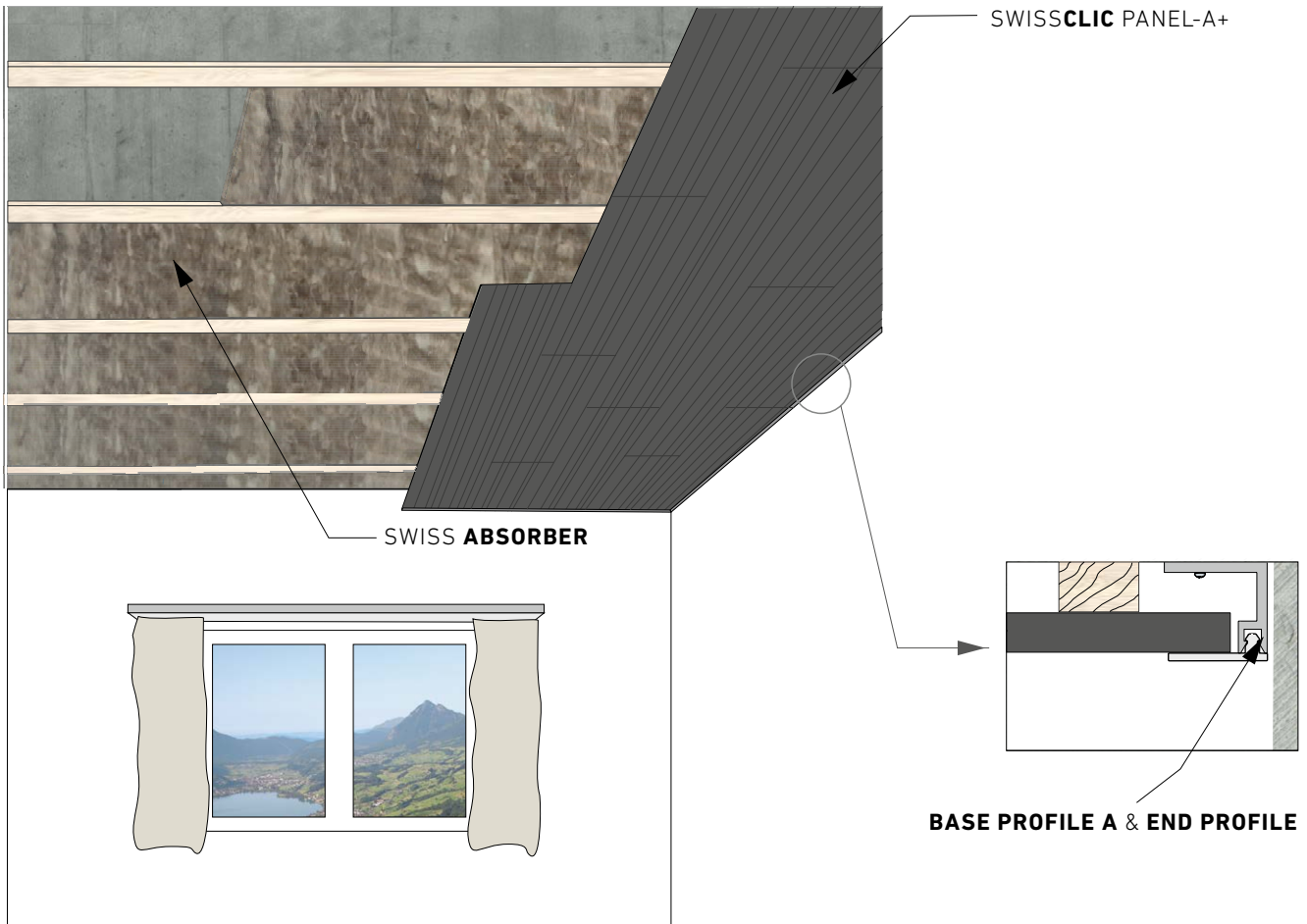



START

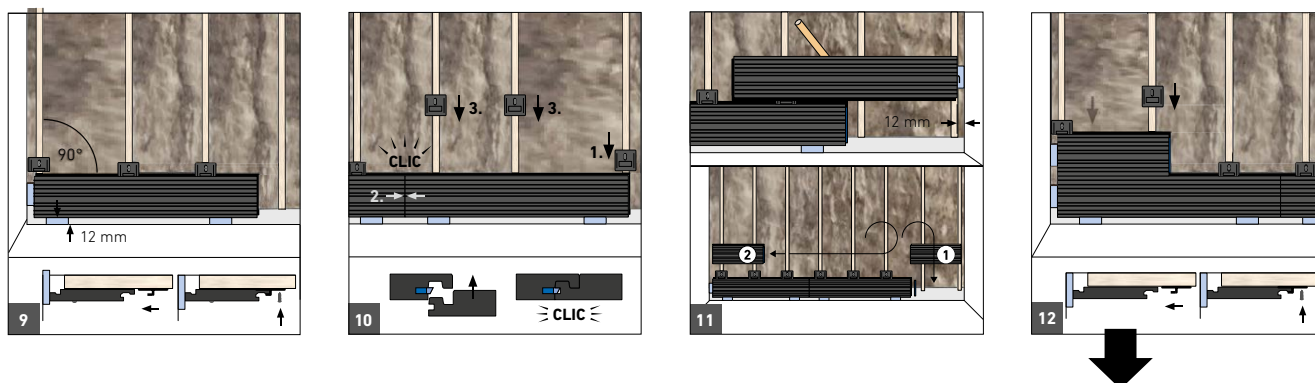
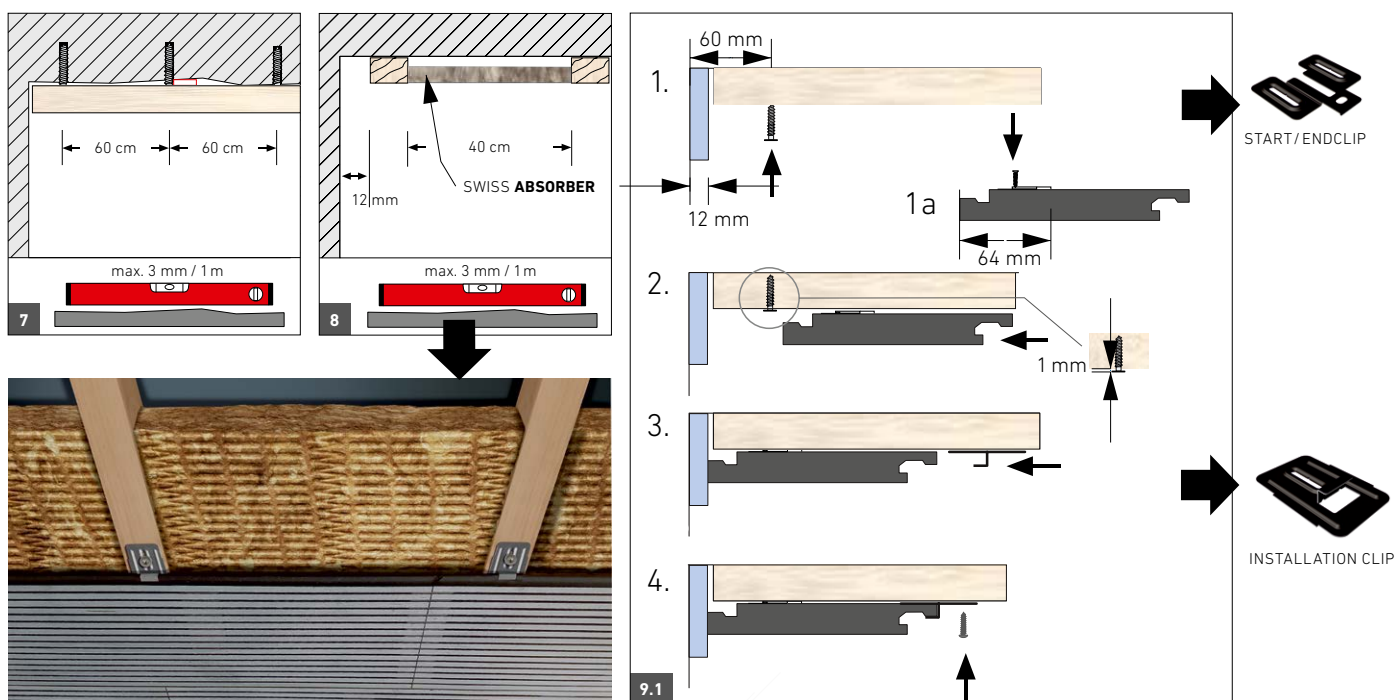

FOR INSTALLATION WITHOUT BASE & END PROFIL

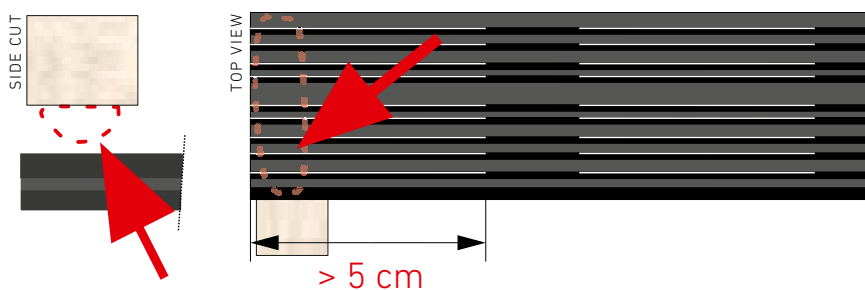

EN

If the distance is > 5 cm = put **elastic silicon glue** between SWISSCLIC PANEL and the wooden subconstruction to hold the small lamellas.

DE

Bei > 5 cm Distanz zum Steg = Setze **elastischen Silikonkleber** zwischen das SWISSCLIC PANEL und die hölzerne Unterkonstruktion um die schmalen Lamellen zu halten.

FR

Pour une distance de > 5 cm jusqu'à la traverse = Mettez une **colle élastique silicone** entre le SWISSCLIC PANEL et la sous-construction en bois pour fixer les minces lamelles.

END

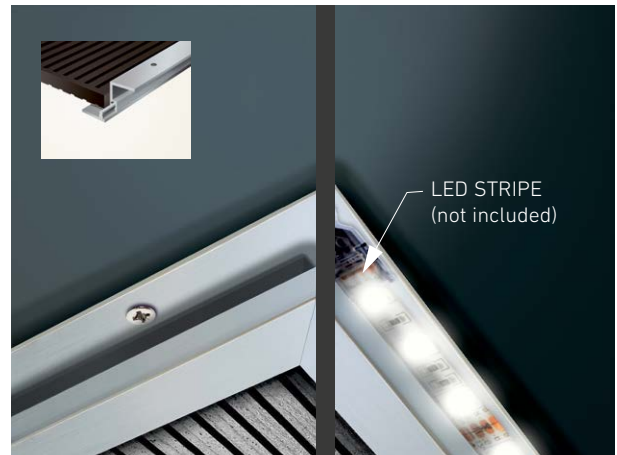
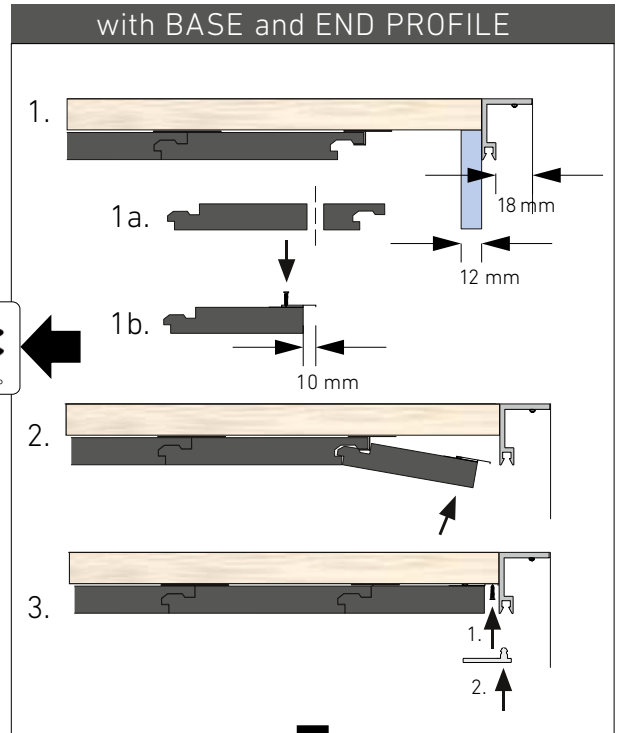
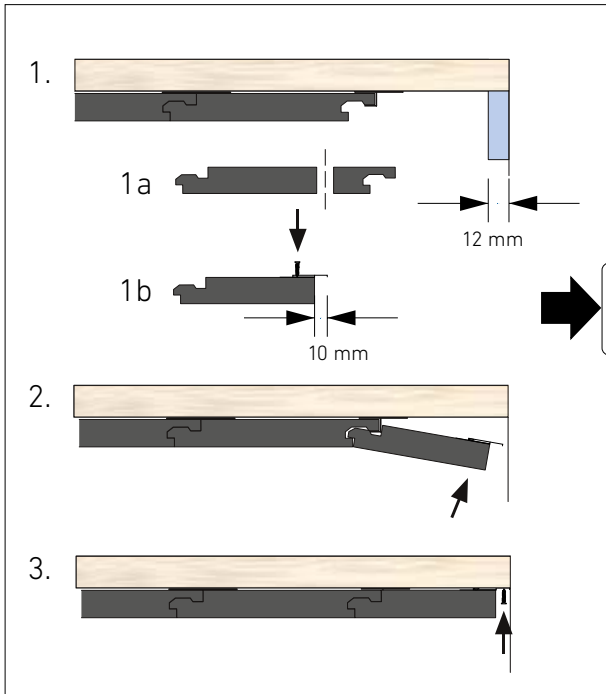

PROFILE



END & DILATATION PROFILE ALUMINIUM

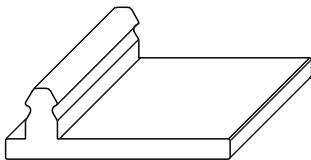

END PROFILE

6 pcs / box

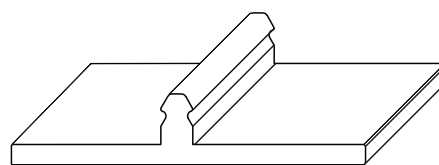

DILATATION PROFILE

2 pcs / box



BASE PROFILE ALUMINIUM

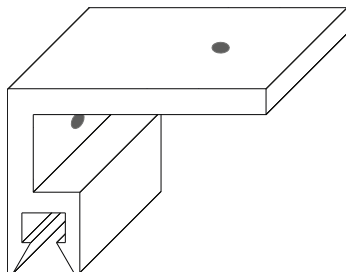

6 pcs / box

WS Nr. 2560



A Nr. 2570

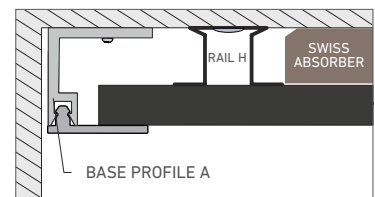
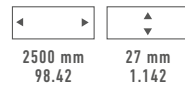

CORNER PROFILE ALUMINIUM

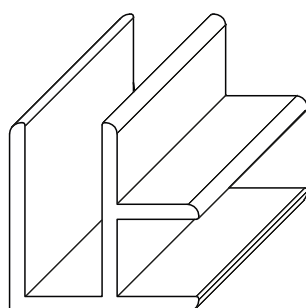

2 pcs / box

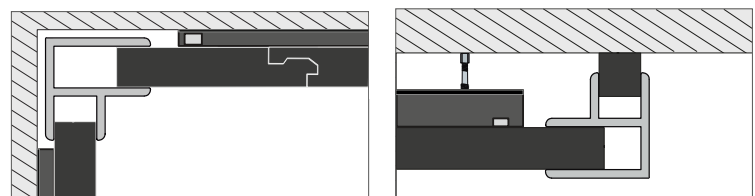

FIXATION WITH RAIL

MULTI-MONTI®-plus FIX-B BETONSCHRAUBE

vis béton | vite cemento | cement screw | tornillo concreto

Nr. 4614

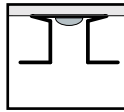
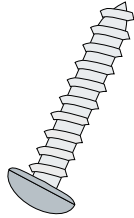

ca. 20 m² / box
100 pces / box



ADAPTER SYSTEM NONIUS NR. 301

für | pour | per | por | para RAIL H

ca. 20 m² / box
100 pces / box

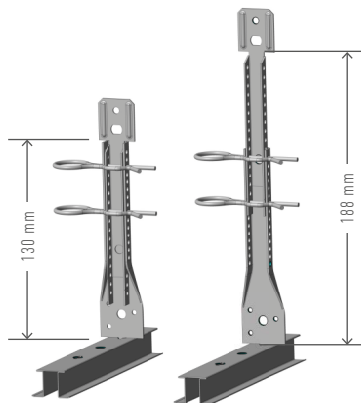
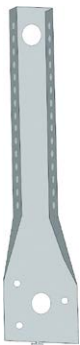

DISTANCE HOLDER NR. 330

ca. 20 m² / box
100 pces / box

